

Model:TLLA2G4G-40-15
Low Noise Amplifier
2-4GHz, NF:1.5dB, Gain:40dB,P1dB:24dBm
Feature:

- Ultra Wide Band: 2-4GHz
- Gain: 40dB Min
- Noise Figure: 1.5dB Max
- Good Power and Gain Flatness
- 50 Ohm Matched Input / Output

电气特性 Electrical:

参数Parameter	Min.	Typ.	Max.	单位Units
频率范围 Frequency range	2-4			GHz
增益 Gain	40	41		dB
噪声系数 Noise Figure		1	1.5	dB
线性输出功率P1dB	20	24		dBm
饱和输出功率 PSat		25		dBm
输入功率 Input Power		5		dBm
输入驻波 Input VSWR		1.6		:1
输出驻波 Output VSWR		1.8		:1
直流电压 DC Voltage	+8	+12	+14	V DC
直流电流 DC Supply Current		320		mA
阻抗 Impedance	50			Ohms

机械特性 Mechanical :

参数Parameter	指标 Value	单位Units
输入输出接口Input /Output Connector	SMA Female	
直流偏置 Bias	Solder Pin	
尺寸 Size	30*28*10	mm
重量 Weight	/	g



 Available 220V System
 Benchtop Amplifier

绝对最大值 Absolute Maximum Ratings:

参数Parameter	指标 Value
供电偏置电压 Supply Bias Voltage	+14V
输入功率 RF INPUT POWER	5 dBm
ESD灵敏度 ESD sensitivity (HBm)	Class 0, passed 150V

外形尺寸 Outline Drawing:

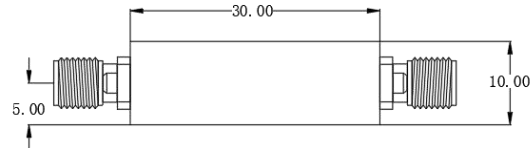
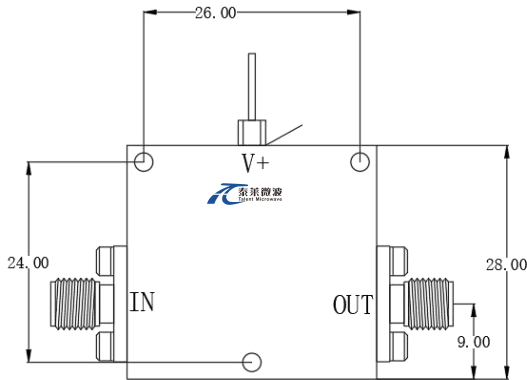
Unit: mm



温度环境 Environmental Conditions:

参数Parameter	Min.	Typ.	Max.	单位Units
操作温度 Operating Temperature	-40		+60	°C
存储温度 Non-operating Temperature	-55		+125	°C
相对湿度 Relative humidity		95		%
海拔 Altitude	50,000			feet
震动 Shock / Vibration(MIL-STD-810F)	25g rms (15 degree 2KHz) endurance, 1 hour per axis			
冲击 Shock(non operating)	20G for 11msc half sin wave,3 axis both directions			

订货信息 Ordering Information:

标准型号 Part Number	描述 Description	版本号Revision
TLLA2G4G-40-15	Low Noise Amplifier, 2-4GHz, Noise Figure:1.5dB, Gain:40dB,P1dB:24dBm,14V DC,Without Heatsink	Rev.1.1